

A Montage

Fixation – Montage

→ **Bitte nur beiliegende Schrauben verwenden!**

Please use only the enclosed screws! - Veuillez utiliser seulement les vis jointes!

SPANNSCHUH

TENSION CORD BRACKET

SUPPORT DE CÂBLES

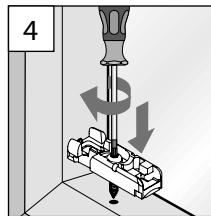
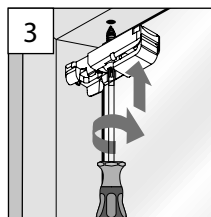
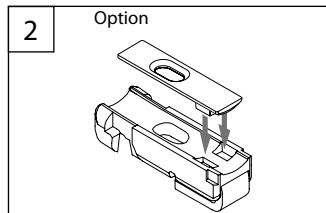
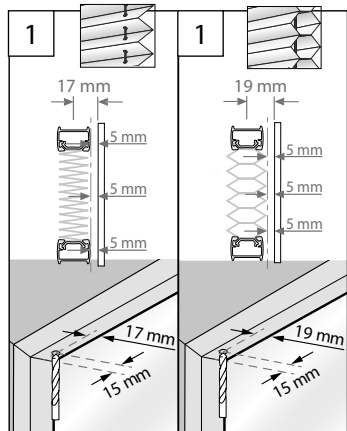
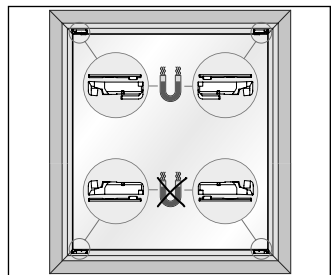

1

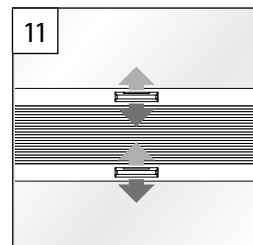
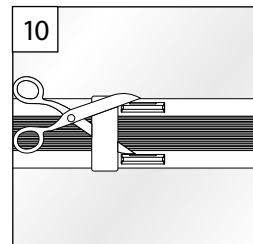
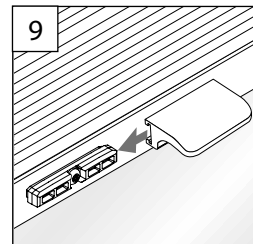
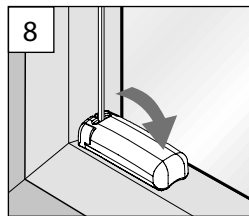
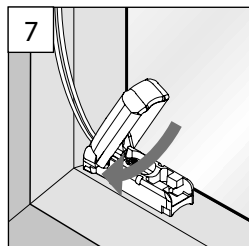
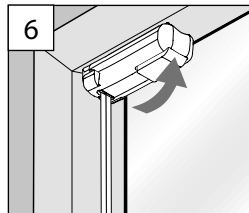
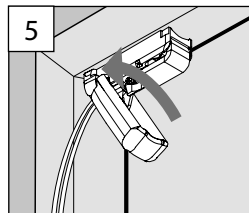

2

WANDWINKEL

WALL FIXING BRACKET - SUPPORT MURAL

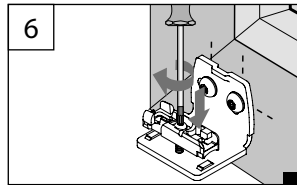
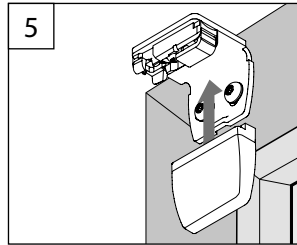
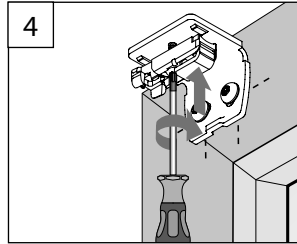
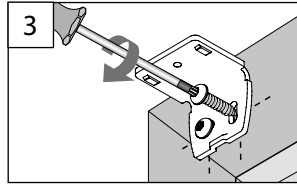
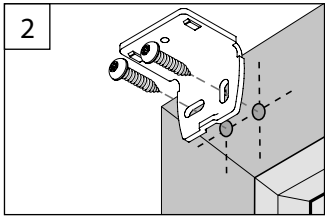
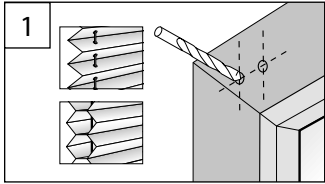
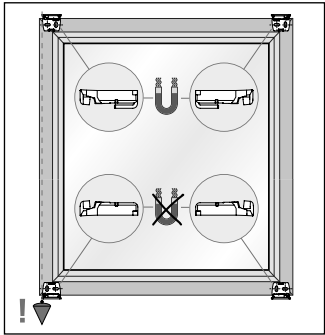

3

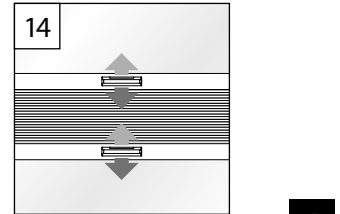
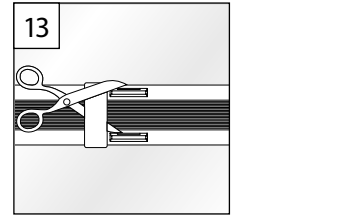
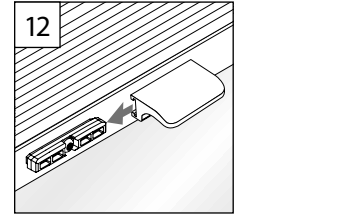
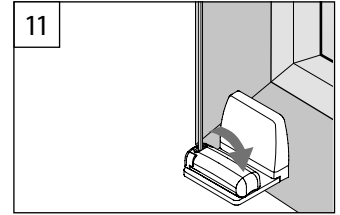
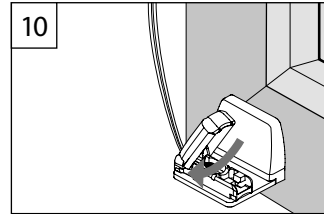
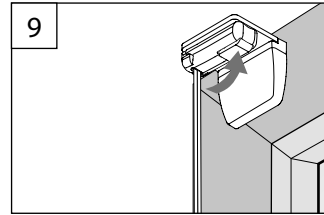
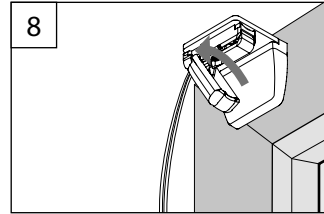
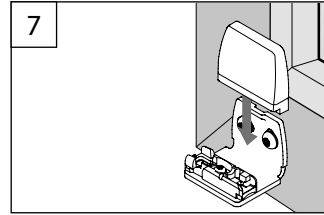

4

B Demontage

Dismantling – Démontage

SPANNSCHUH

TENSION CORD BRACKET – SUPPORT DE CÂBLES

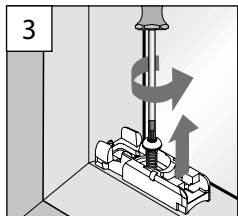
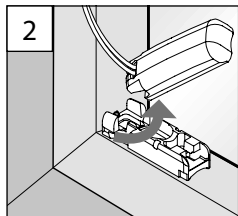
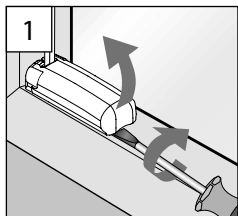

WANDWINKEL

WALL FIXING BRACKET – SUPPORT MURAL

